



用户操作手册



慎重保证

◆ 安全要求

—防止火灾或人身伤害

•

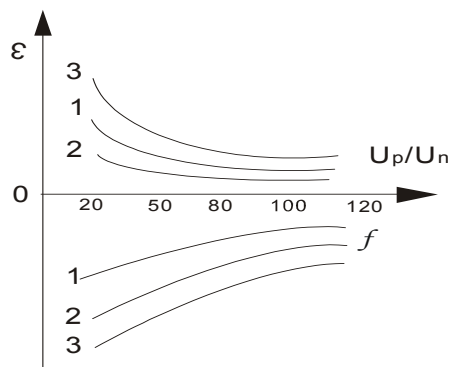
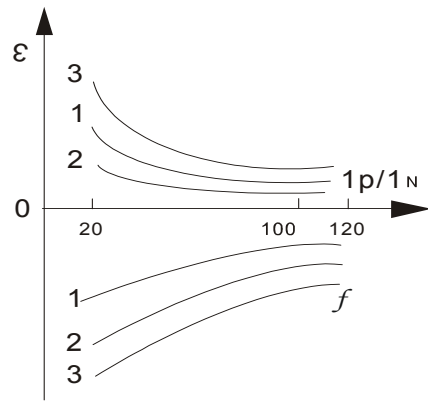

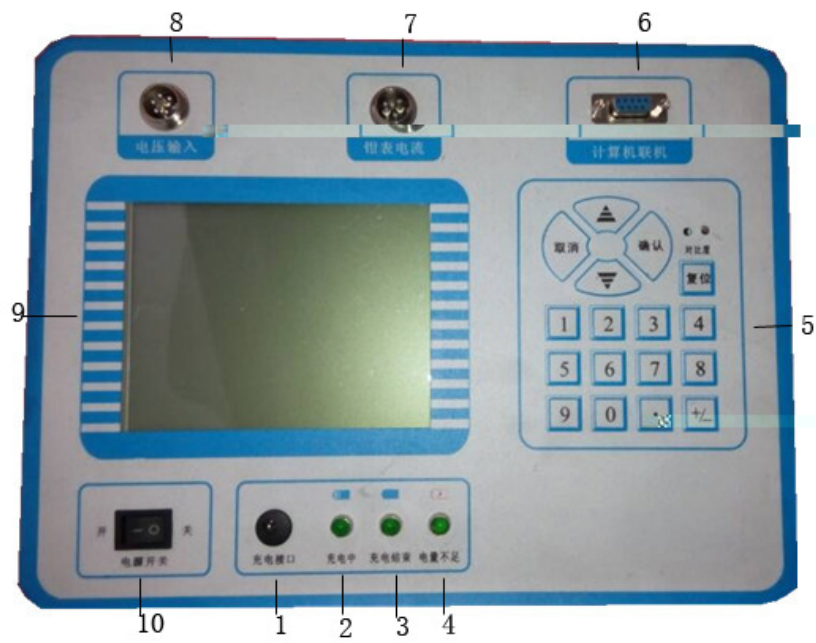

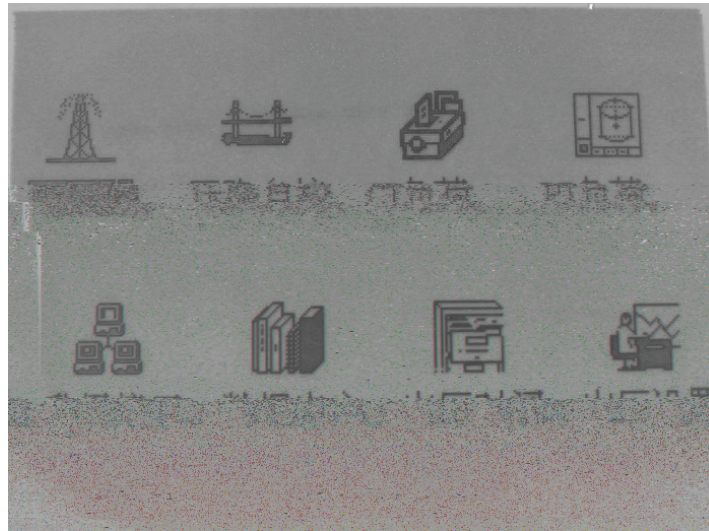

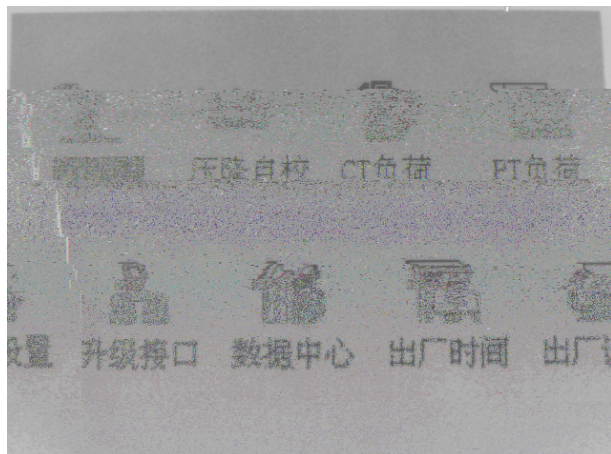
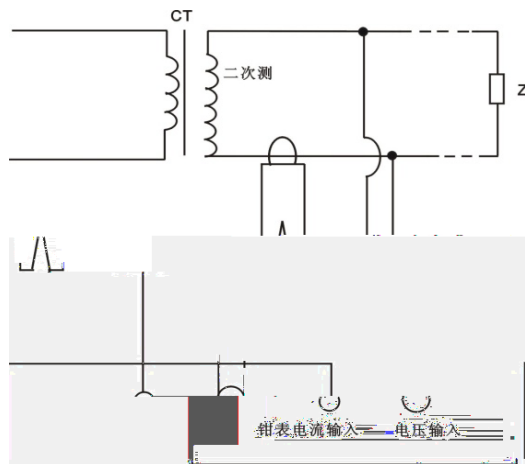

CT负荷	
二次电流	5 A
测试日期	20070000
温度	20.0 °C

二次电流	5.000 A	
温度	20.0 C	湿度 80.0 %
计量点编号	22222222	
测试日期	20070000	
I(Z) =	U(V) =	
I(A) =	Z(Q) =	
R(Q) =	S(va) =	
X(Q) =	φ =	

$$U = I\sqrt{R^2 + X^2}$$

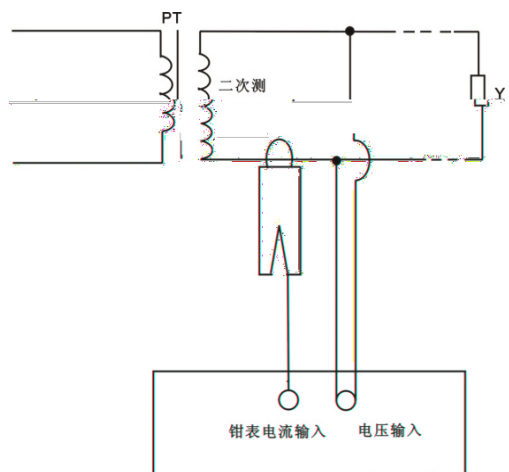

PT负荷

二次电压	100 V
测试日期	20070000
温 度	20.0 °C
湿 度	80.0 %
计量点编号	22222222
开始测量	

二次电压	100.0 V	温 度	20.0 °C	湿 度	80.0 %
计量点编号	22222222				
测试日期	20070000				
U(%) = 46.77		I(A) = 0.004			
U(V) = 46.77		Y(ms) = 0.099			
G(ms) = 0.001		S(wa) = 0.017			
B(ms) = 0.099		φ = 90.5			
按2 删除所有数据			按1 传输		

$$I = U\sqrt{G^2 + B^2}$$

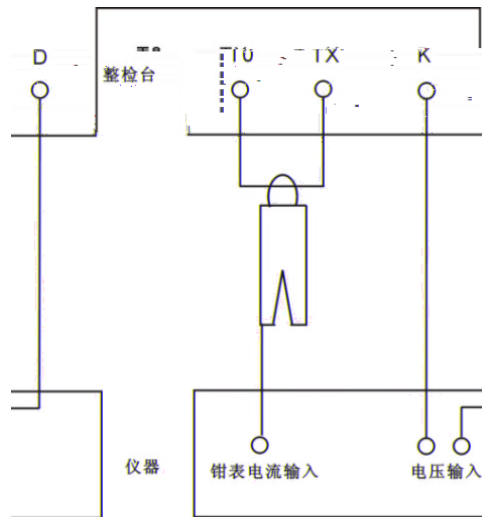

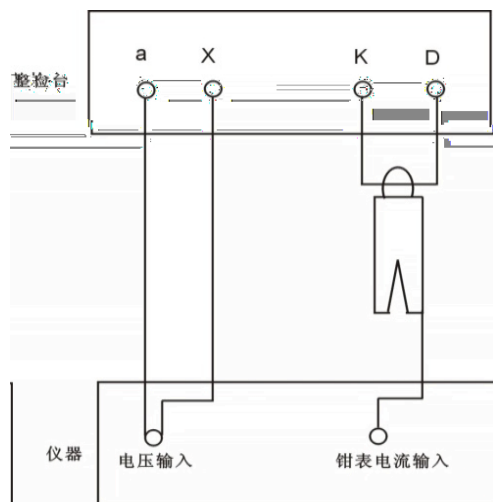

序号	名称	数量	单位	核实
1		1		

2		1		
3		1		
4		1		
5		1		
6		1		
7		1		
8		1		
9		1		
10		1		